



9150 VEHICULAR SLIDE GATE OPERATOR



Metal Cover

Polypropylene Cover

Quiet, reliable & outstanding safety features

- Electronic magnetic limits eliminate old style mechanical switches that can wear out, break or fail
- Automatic self-setting limits mean no limit switch adjustments - ever
- Safety - built-in mechanical and electronic reverse system
- Advanced microprocessor control board features programming switches to set the mode of operation required and has ports for DKS plug-in loop detectors to simplify wiring
- 5-Year limited warranty

RESIDENTIAL • COMMERCIAL • INDUSTRIAL



Entrapment Prevention
reverses gate when obstructed



Gate Tracker™
record users access



Fail-safe Release
never be locked out (or in)

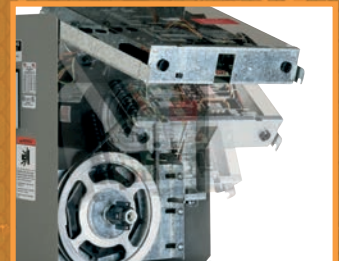

Unique Design
allows easy access to all mechanical parts

ACCESS CONTROL SOLUTIONS



9150 VEHICULAR SLIDE GATE OPERATOR

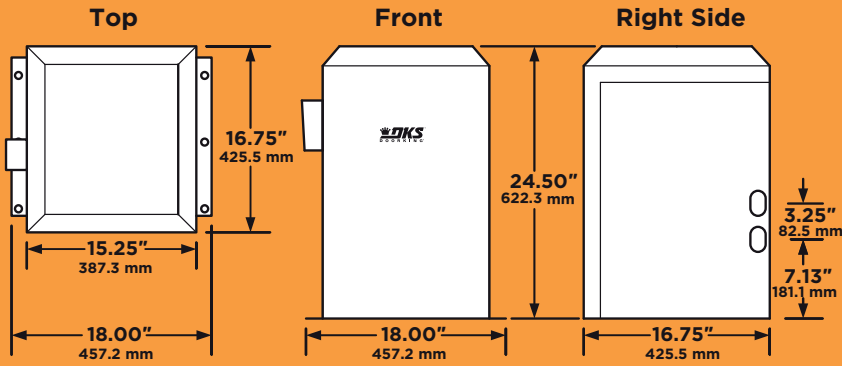

Metal Cover

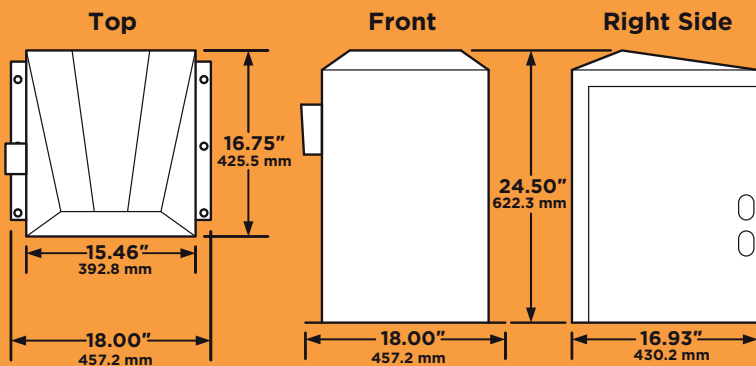

Polypropylene Cover

9150	1/2 HP	1 HP
CLASS OF OPERATION	I, II, III, IV	I, II, III, IV
MAX GATE LENGTH*	30 ft (9.1 m)	45 ft (13.7 m)
MAX GATE WEIGHT*	1000 lb (454 kg)	1500 lb (680 kg)
MOTOR	1/2 HP Continuous Duty AC Motor	1 HP Continuous Duty AC Motor
INPUT	115 VAC, 60 Hz, 5.4A 208 VAC, 60 Hz, 2.8A** 230 VAC, 60 Hz, 2.7A** 460 VAC, 60 Hz, 1.4A**	115 VAC, 60 Hz, 9.7A 208 VAC, 60 Hz, 5.0A** 230 VAC, 60 Hz, 4.9A** 460 VAC, 60 Hz, 2.7A**

* Assumes gate is on level ground, in good condition with properly adjusted hardware. Other external factors may affect the performance of the gate operator.

** These operators use a step-down transformer to achieve 115 VAC operating voltage.

TECHNICAL FEATURES

MECHANICAL

- Frame: G90 galvanized steel to prevent rusting
- Cover: Steel or polypropylene cover available
- Primary Reduction: Single cog belt
- Speed: Approximately 10 in/sec (254 mm/sec)
- Chain: Unit is shipped with 20 ft (6 m) of #40 roller chain, chain brackets, hardware
- Fail-safe release standard

GATE TRACKER™

Reporting output provides operator data to a DKS 1833, 1835, 1837 or 1838 access control system (requires 2358 expansion board)

OPTIONS

- Heater kit for cold weather environments
- Base plate for post mounting
- Fail-secure release kit

ELECTRICAL

- Automatic limit adjustment
- Auto-close timer 1-23 sec
- Selectable stop / reverse loop function
- Built-in On / Off switch
- Built-in alarm reset switch
- Programming switches allow you to set desired mode of operation
- Partial-open and anti-tailgating features
- Two 115 VAC convenience outlets for accessory transformers
- Automatically assumes fail-safe mode when an entrapment condition exists
- Ports for plug-in open and reverse loop detectors (DKS plug-in detectors only)

MISCELLANEOUS

- Environmental: 10°F to 140°F (-12°C to 62°C)
- Thermostatically controlled heater kit recommended for colder environments.
- Operator requires monitored Type B1 and/or Type B2 entrapment protection devices
- Shipping weight approximately 125-185 lb (68-84 kg)



Conforms To ANSI/CAN/UL 325:2017 Ed. 7
Certified To CSA C22.2 #247

DoorKing® Inc.

Access Control Solutions since 1948



120 S. Glasgow Avenue,
Inglewood, California 90301 U.S.A.
Tel: 310-645-0023 FAX: 310-641-1586
www.doorking.com

© 2020 All Rights Reserved.
Product specifications may
change without notice. Rev. 11/20



MEMBER:



DISTRIBUTED BY:

